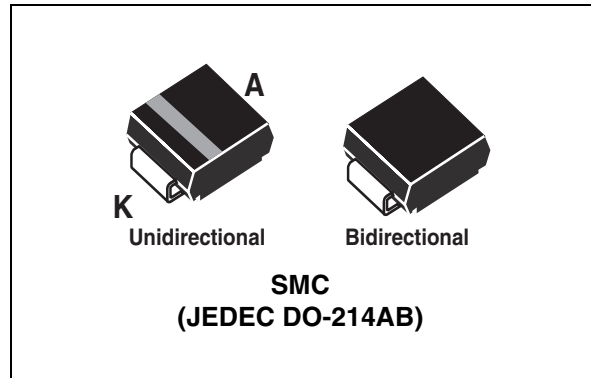


### Features

- Peak pulse power: 1500 W (10/1000  $\mu$ s)
- Breakdown voltage range: from 6.8 V to 220 V
- Uni and bidirectional types
- Low clamping factor
- Fast response time
- UL recognized

### Description

Transil diodes provide high overvoltage protection by clamping action. Their instantaneous response to transient overvoltages makes them particularly suited to protect voltage sensitive devices such as MOS Technology and low voltage supplied IC's.



### Order code

Part number	Marking
SM15TxxxA	See <a href="#">Table 5 on page 7</a>
SM15TxxxCA	See <a href="#">Table 5 on page 7</a>

**Table 1. Absolute maximum ratings ( $T_{amb} = 25^{\circ} C$ )**

Symbol	Parameter	Value	Unit
$P_{PP}$	Peak pulse power dissipation <sup>(1)</sup>	$T_j \text{ initial} = T_{amb}$ 1500	W
P	Power dissipation on infinite heatsink	$T_{amb} = 50^{\circ} C$ 6.5	W
$I_{FSM}$	Non repetitive surge peak forward current for unidirectional types	$t_p = 10ms$ $T_j \text{ initial} = T_{amb}$ 200	A
$T_{stg}$	Storage temperature range	-65 to + 175	$^{\circ}C$
$T_j$	Maximum operating junction temperature	150	$^{\circ}C$
$T_L$	Maximum lead temperature for soldering during 10 s.	260	$^{\circ}C$

1. For a surge greater than the maximum values, the diode will fail in short-circuit.

**Table 2. Thermal parameter**

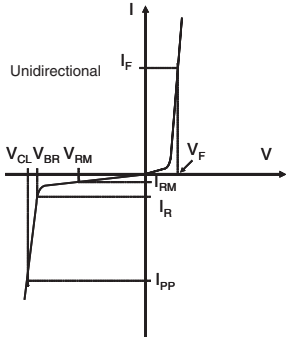
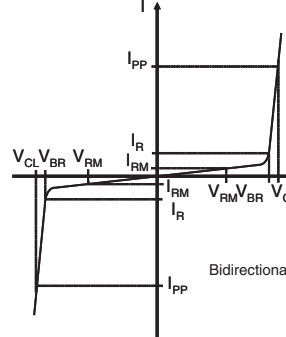
Symbol	Parameter	Value	Unit
$R_{th(j-l)}$	Junction to leads	15	$^{\circ}C/W$
$R_{th(j-a)}$	Junction to ambient on printed circuit on recommended pad layout	75	$^{\circ}C/W$

TM: TRANSIL is a trademark of STMicroelectronics

# 1 Characteristics

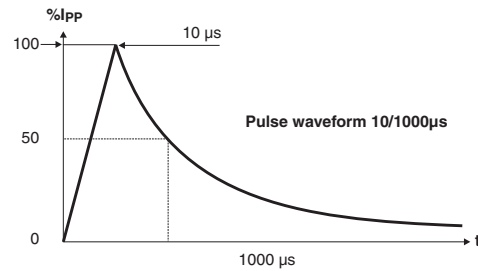
**Table 3. Electrical characteristics**

Symbol	Parameter
$V_{BR}$	Breakdown voltage
$I_{RM}$	Leakage current @ $V_{RM}$
$V_{RM}$	Stand-off voltage
$V_{CL}$	Clamping voltage
$R_d$	Dynamic impedance
$\alpha T$	Voltage temperature coefficient
$I_{PP}$	Peak pulse current

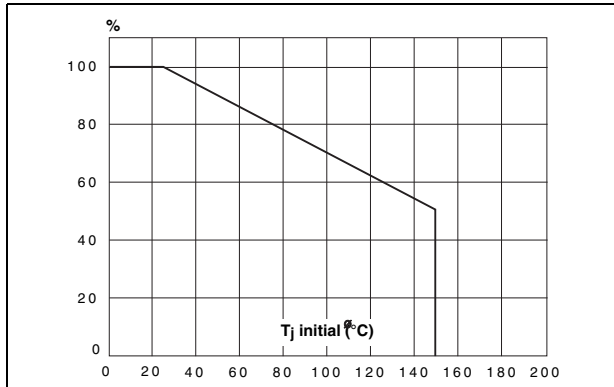



Type	$I_{RM} @ V_{RM}$ max		$V_{BR} @ I_R^{(1)}$				$V_{CL} @ I_{PP}$ 10/1000 $\mu s$		$V_{CL} @ I_{PP}$ 8/20 $\mu s$		$\alpha T$ max <sup>(2)</sup>	C typ <sup>(3)</sup>
			min	nom	max		max		max			
	$\mu A$	V	V	V	V	mA	V	A	V	A	$10^{-4}/^{\circ}C$	pF
SM15T6V8A/CA	1000	5.8	6.45	6.8	7.14	10	10.5	143	13.4	746	5.7	9500
SM15T7V5A/CA	500	6.4	7.13	7.5	7.88	10	11.3	132	14.5	690	6.1	8500
SM15T10A/CA	10	8.55	9.5	10	10.5	1	14.5	103	18.6	538	7.3	7000
SM15T12A/CA	5	10.2	11.4	12	12.6	1	16.7	90	21.7	461	7.8	6000
SM15T15A/CA	1	12.8	14.3	15	15.8	1	21.2	71	27.2	368	8.4	5000
SM15T18A/CA	1	15.3	17.1	18	18.9	1	25.2	59.5	32.5	308	8.8	4300
SM15T22A/CA	1	18.8	20.9	22	23.1	1	30.6	49	39.3	254	9.2	3700
SM15T24A/CA	1	20.5	22.8	24	25.2	1	33.2	45	42.8	234	9.4	3500
SM15T27A/CA	1	23.1	25.7	27	28.4	1	37.5	40	48.3	207	9.6	3200
SM15T30A/CA	1	25.6	28.5	30	31.5	1	41.5	36	53.5	187	9.7	2900
SM15T33A/CA	1	28.2	31.4	33	34.7	1	45.7	33	59.0	169	9.8	2700
SM15T36A/CA	1	30.8	34.2	36	37.8	1	49.9	30	64.3	156	9.9	2500
SM15T39A/CA	1	33.3	37.1	39	41.0	1	53.9	28	69.7	143	10.0	2400
SM15T68A/CA	1	58.1	64.6	68	71.4	1	92	16.3	121	83	10.4	1550
SM15T75A/CA	1	64.1	71.3	---	78.8	1	103	14.6	134	75	10.5	1450
SM15T100A/CA	1	85.5	95.0	100	105	1	137	11	178	56	10.6	1150
SM15T150A/CA	1	128	143	150	158	1	207	7.2	265	38	10.8	850
SM15T200A/CA	1	171	190	200	210	1	274	5.5	353	28	10.8	675
SM15T220A/CA	1	188	209	220	231	1	328	4.6	388	26	10.8	625

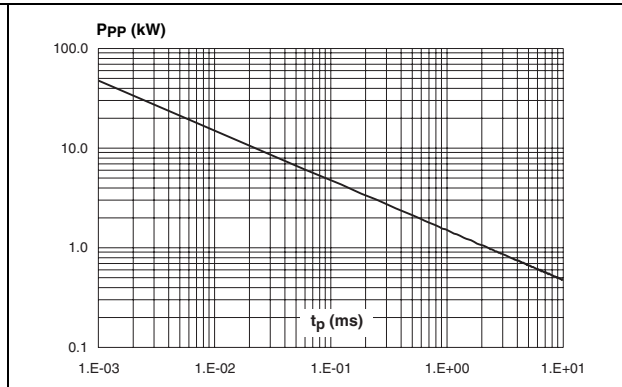
1. Pulse test:  $t_p < 50$  ms.
2.  $\Delta V_{BR} = \alpha T * (T_{amb} - 25) * V_{BR} (25^{\circ}C)$
3.  $V_R = 0$  V,  $F = 1$  MHz. For bidirectional types capacitance value is divided by 2.



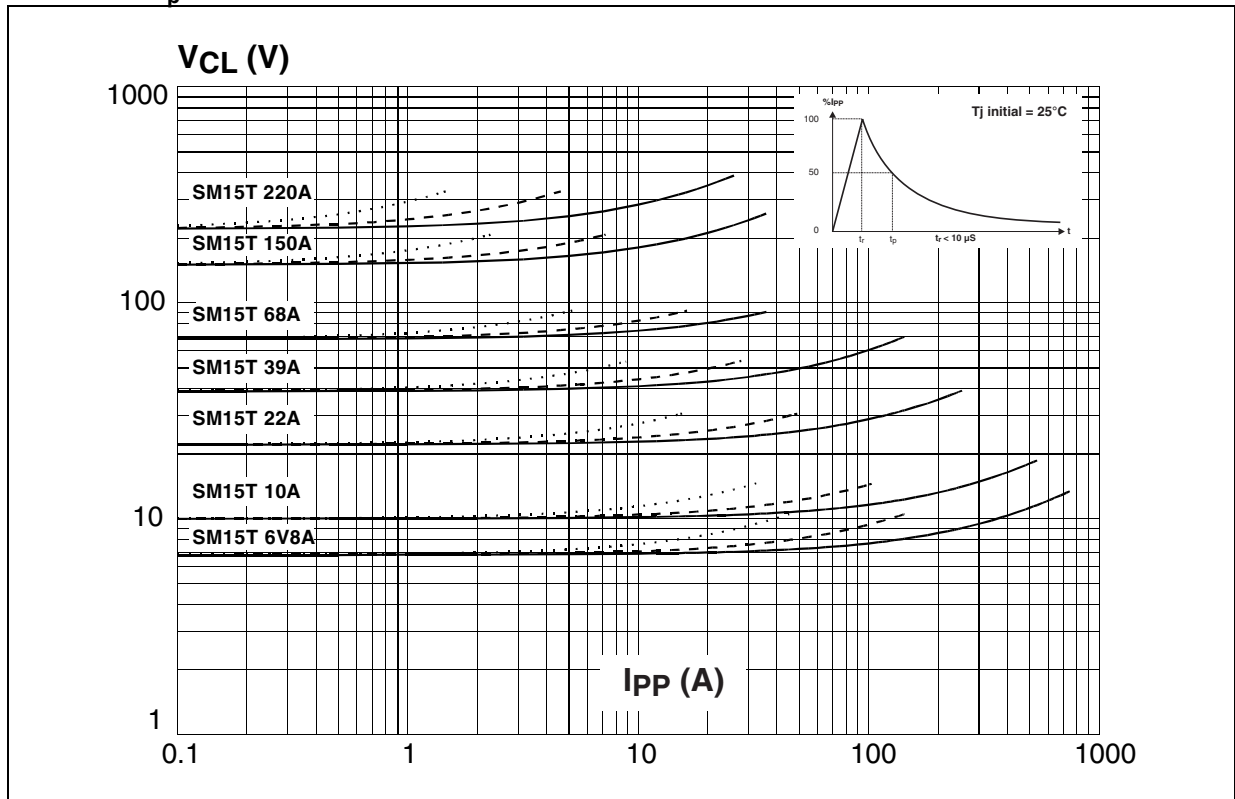
**Figure 1. Peak pulse power dissipation versus initial junction temperature (printed circuit board)**



**Figure 2. Peak pulse power versus exponential pulse duration**

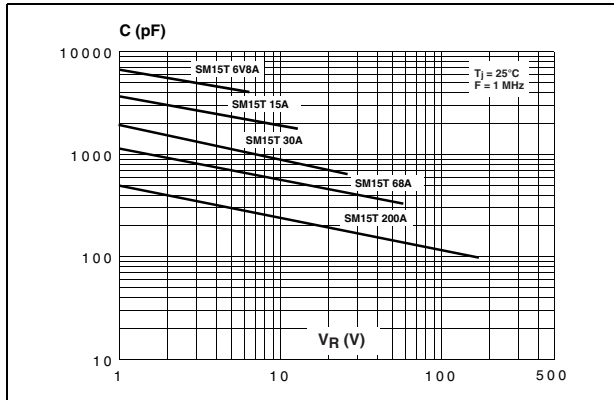


**Figure 3. Clamping voltage versus peak pulse current**  
 Exponential waveform  $t_p = 20 \text{ ms}$   
 $t_p = 1 \text{ ms}$  —————  
 $t_p = 10 \text{ ms}$ .....

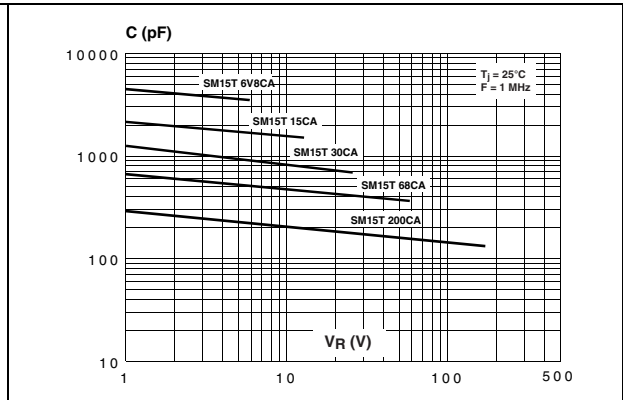


**Note:** The curves of figure 3 are specified for a junction temperature of 25° C before surge. The given results may be extrapolated for other junction temperatures by using the following formula:  
 $\Delta V_{BR} = \alpha T * [T_{amb} - 25] * V_{BR} (25^\circ C)$   
 For intermediate voltages, extrapolate the given results.

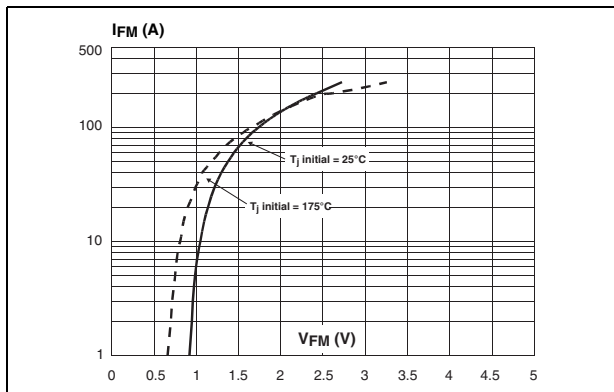
**Figure 4. Capacitance versus reverse applied voltage for unidirectional types (typical values)**



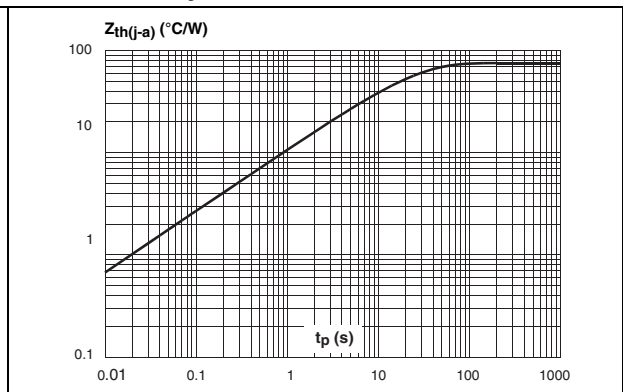
**Figure 5. Capacitance versus reverse applied voltage for bidirectional types (typical values)**



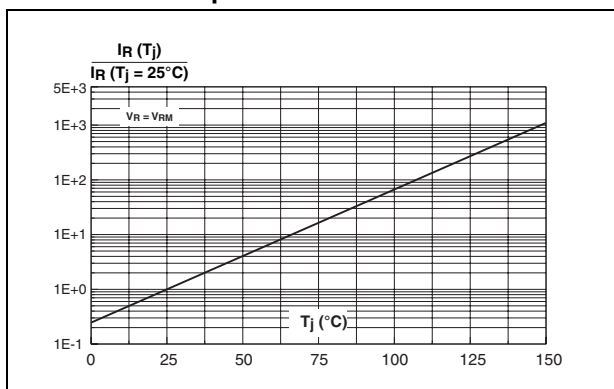
**Figure 6. Peak forward voltage drop versus peak forward current (typical values for unidirectional types)**



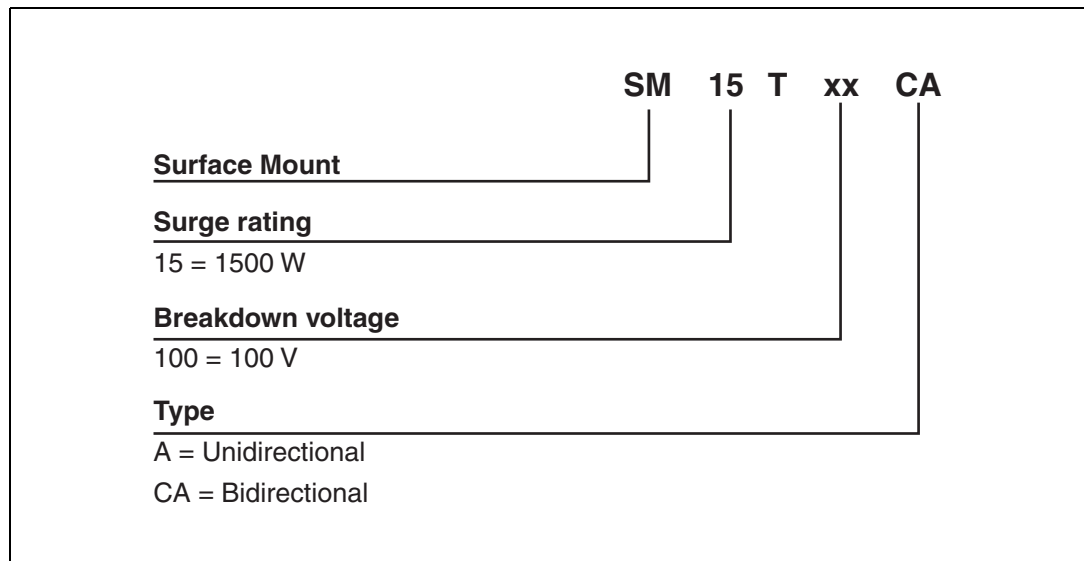
**Figure 7. Transient thermal impedance junction-ambient versus pulse duration - mounting on FR4 PC board with recommended pad layout**



**Figure 8. Relative variation of leakage current versus junction temperature**



## 2 Ordering information scheme



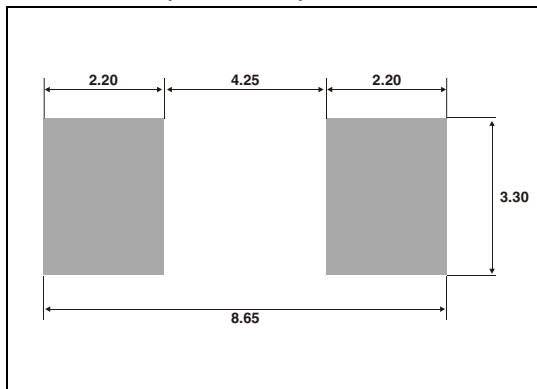
### 3 Package mechanical data

- Case: JEDEC DO-214AB molded plastic over Planar junction
- Terminals: Solder plated, solderable per MIL-STD-750, Method 2026
- Polarity: For unidirectional types the band indicates cathode
- Flammability: Epoxy is rated UL94V-0
- RoHS package

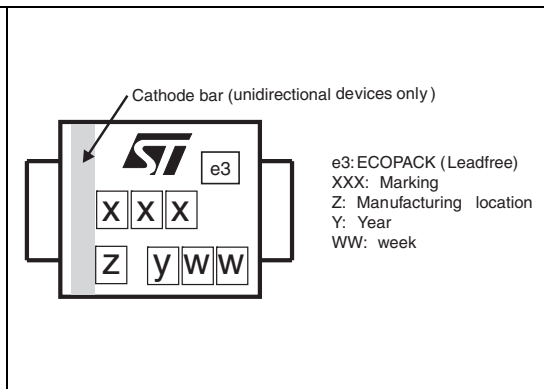
**Table 4. SMC dimensions**

Ref.	Dimensions			
	Millimeters		Inches	
	Min.	Max.	Min.	Max.
A1	1.90	2.45	0.075	0.096
A2	0.05	0.20	0.002	0.008
b	2.90	3.2	0.114	0.126
c	0.15	0.41	0.006	0.016
E	7.75	8.15	0.305	0.321
E1	6.60	7.15	0.260	0.281
E2	4.40	4.70	0.173	0.185
D	5.55	6.25	0.218	0.246
L	0.75	1.60	0.030	0.063

**Figure 9. Footprint dimensions (millimeter)**



**Figure 10. Marking layout**



**Table 5. Marking**

Unidirectional	Marking	Bidirectional	Marking
SM15T6V8A	MDE	SM15T6V8CA	BDE
SM15T7V5A	MDG	SM15T7V5CA	BDG
SM15T10A	MDP	SM15T10CA	BDP
SM15T12A	MDT	SM15T12CA	BDT
SM15T15A	MDX	SM15T15CA	BDX
SM15T18A	MEE	SM15T18CA	BEE
SM15T22A	MEK	SM15T22CA	BEK
SM15T24A	MEM	SM15T24CA	BEM
SM15T27A	MEP	SM15T27CA	BEP
SM15T30A	MER	SM15T30CA	BER
SM15T33A	MET	SM15T33CA	BET
SM15T36A	MEV	SM15T36CA	BEV
SM15T39A	MEX	SM15T39CA	BEX
SM15T68A	MFP	SM15T68CA	BFP
SM15T75A	MFO	SM15T75CA	BFO
SM15T100A	MFX	SM15T100CA	BFX
SM15T150A	MGK	SM15T150CA	BGK
SM15T200A	MGV	SM15T200CA	BGV
SM15T220A	MGX	SM15T220CA	BGX

In order to meet environmental requirements, ST offers these devices in ECOPACK® packages. These packages have a Lead-free second level interconnect . The category of second level interconnect is marked on the package and on the inner box label, in compliance with JEDEC Standard JESD97. The maximum ratings related to soldering conditions are also marked on the inner box label. ECOPACK is an ST trademark. ECOPACK specifications are available at: [www.st.com](http://www.st.com).

## 4 Ordering information

Part number	Marking	Package	Weight	Base qty	Delivery mode
SM15TxxxA	See <a href="#">Table 5 on page 7</a>	SMC	0.25 g	5000	Tape and reel
SM15TxxCA	See <a href="#">Table 5 on page 7</a>				

## 5 Revision history

Date	Revision	Description of Changes
September-2001	3B	Last issue
19-Feb-2007	4	Reformatted to current standards. Peak pulse power <a href="#">Figure 2 on page 3</a> updated.



**Please Read Carefully:**

Information in this document is provided solely in connection with ST products. STMicroelectronics NV and its subsidiaries ("ST") reserve the right to make changes, corrections, modifications or improvements, to this document, and the products and services described herein at any time, without notice.

All ST products are sold pursuant to ST's terms and conditions of sale.

Purchasers are solely responsible for the choice, selection and use of the ST products and services described herein, and ST assumes no liability whatsoever relating to the choice, selection or use of the ST products and services described herein.

No license, express or implied, by estoppel or otherwise, to any intellectual property rights is granted under this document. If any part of this document refers to any third party products or services it shall not be deemed a license grant by ST for the use of such third party products or services, or any intellectual property contained therein or considered as a warranty covering the use in any manner whatsoever of such third party products or services or any intellectual property contained therein.

**UNLESS OTHERWISE SET FORTH IN ST'S TERMS AND CONDITIONS OF SALE ST DISCLAIMS ANY EXPRESS OR IMPLIED WARRANTY WITH RESPECT TO THE USE AND/OR SALE OF ST PRODUCTS INCLUDING WITHOUT LIMITATION IMPLIED WARRANTIES OF MERCHANTABILITY, FITNESS FOR A PARTICULAR PURPOSE (AND THEIR EQUIVALENTS UNDER THE LAWS OF ANY JURISDICTION), OR INFRINGEMENT OF ANY PATENT, COPYRIGHT OR OTHER INTELLECTUAL PROPERTY RIGHT.**

**UNLESS EXPRESSLY APPROVED IN WRITING BY AN AUTHORIZED ST REPRESENTATIVE, ST PRODUCTS ARE NOT RECOMMENDED, AUTHORIZED OR WARRANTED FOR USE IN MILITARY, AIR CRAFT, SPACE, LIFE SAVING, OR LIFE SUSTAINING APPLICATIONS, NOR IN PRODUCTS OR SYSTEMS WHERE FAILURE OR MALFUNCTION MAY RESULT IN PERSONAL INJURY, DEATH, OR SEVERE PROPERTY OR ENVIRONMENTAL DAMAGE. ST PRODUCTS WHICH ARE NOT SPECIFIED AS "AUTOMOTIVE GRADE" MAY ONLY BE USED IN AUTOMOTIVE APPLICATIONS AT USER'S OWN RISK.**

Resale of ST products with provisions different from the statements and/or technical features set forth in this document shall immediately void any warranty granted by ST for the ST product or service described herein and shall not create or extend in any manner whatsoever, any liability of ST.

ST and the ST logo are trademarks or registered trademarks of ST in various countries.

Information in this document supersedes and replaces all information previously supplied.

The ST logo is a registered trademark of STMicroelectronics. All other names are the property of their respective owners.

© 2007 STMicroelectronics - All rights reserved

STMicroelectronics group of companies

Australia - Belgium - Brazil - Canada - China - Czech Republic - Finland - France - Germany - Hong Kong - India - Israel - Italy - Japan - Malaysia - Malta - Morocco - Singapore - Spain - Sweden - Switzerland - United Kingdom - United States of America

[www.st.com](http://www.st.com)